



PicSight.com

P34M-PoCL

Camera Link monochrome camera

- 1/4 inch progressive scan CCD
- 656 × 494 square pixels
- 64 fps, 12-bit image data
- high sensitivity
- async reset, full frame shutter
- mini Camera Link connector
- power over Camera Link (PoCL)
- embedded real-time functions
- 12-bit data LUT





1/4" CCD Sensor	SONY ICX098
Readout	interline transfer
Sensor size (H×V)	4.6 × 3.97 mm
Output image resolution (H×V)	656 × 494 pixels
Pixel size	5.6 × 5.6 μm
Color	monochrome
Scan	progressive
Frame rate	64 frames/sec
Shutter	global
Max. shutter time	20 ms
Min. shutter time	10 μs
Lens mount	C-mount

Spectral sensitivity

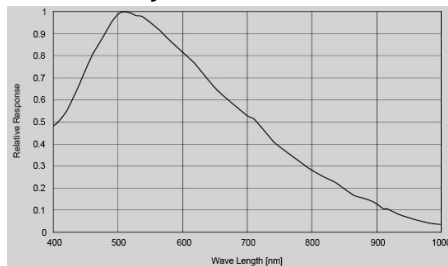

Interface

Camera Link	Base
Connector	SDR mini CL
Status control	Status LED
Power	10–15 V
Weight	90 g
Operating temperature	0–50 °C

Embedded Realtime Function RTF

Available	12-bit data LUT
Optional	5×5 Bayer decoding 12-bit Bayer → 24-bit RGB
Optional	Color to monochrome conversion
On request	User functions

Software

Camera configuration Windows	Standard Camera Link API
Camera configuration Windows/Linux	LV-SDS camera control API, Camera Editor
Firmware update	With Leutron FW update tool (Windows)

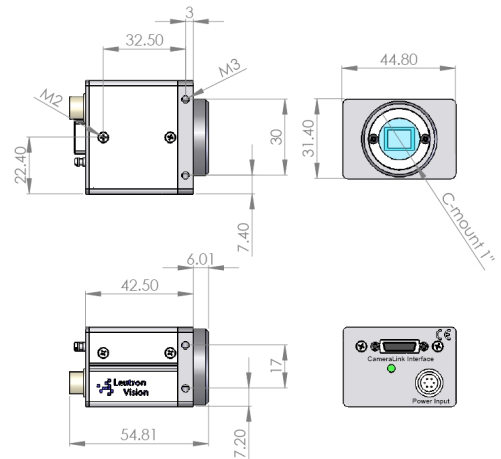

SDR 26-pin connector, female,
3M:12226-100-00 SN79155-S

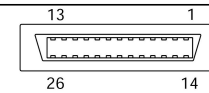

Pin	Signal	Pin	Signal
1	Power (PoCL)	14	Power return (PoCL)
2	Serial data 0 -	15	Serial data 0 +
3	Serial data 1 -	16	Serial data 1 +
4	Serial data 2 -	17	Serial data 2 +
5	Serial data Clock -	18	Serial data Clock +
6	Serial data 3 -	19	Serial data 3 +
7	Serial Communication to Camera +	20	Serial Communication to Camera -
8	Serial Communication to Grabber -	21	Serial Communication to Grabber +
9	CC1-	22	CC1+
10	CC2+	23	CC2-
11	CC3-	24	CC3+
12	CC4+	25	CC4-
13	Power return (PoCL)	26	Power (PoCL)

Hirose 6-pin connector, male,
HR10A-7R-6PB-73

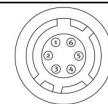

Pin	Signal
1, 2	Power Input
3, 4	Reserved
5, 6	Ground

Ordering numbers

Number	Product name	Option
100052	PicSight P34M-PoCL	
100077	PicSight P34M-PoCL-RTF	Realtime function
999000	Mounting plate	For USB/CL cameras
16028	LV-SDS	Software API

International headquarters Switzerland
Leutron Vision AG
Industriestrasse 57
CH-8152 Glattbrugg, Switzerland
Phone ++41 44 809 88 22
fax ++41 44 809 88 29
intsales@leutron.com
www.leutron.com

Germany
Leutron Vision GmbH
Macairestrasse 3
D-78467 Konstanz, Germany
Phone ++49 7531 5942 0
fax ++49 7531 594299
desales@leutron.com
www.leutron-vision.de

North America
Leutron Vision Inc.
38 East Street
Halifax, MA 02338, USA
Phone: ++1 888 442 2269 x1
Fax: ++1 781 353 3943
ussales@leutron.com
www.leutron.com/

