

PicSight P32M-GigE-AS

GigE Vision camera

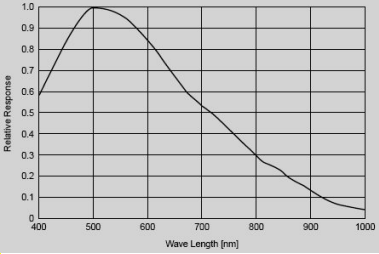

Technical specifications

Interface	Ethernet 1000/100/10 Mb/s
Sensor	1/2" CCD, interline transfer, type SONY ICX414
Spectral sensitivity	 <p>The graph shows the relative response of the sensor across a range of wavelengths from 400 nm to 1000 nm. The y-axis is labeled 'Relative Response' and ranges from 0 to 1.0. The x-axis is labeled 'Wave Length (nm)' and ranges from 400 to 1000. The curve starts at approximately 0.5 at 400 nm, rises to a peak of 1.0 at 500 nm, and then gradually declines to about 0.1 at 1000 nm.</p>
Monochrome/color	monochrome
Output image resolution (H×V)	656 × 494 pixels
Full sensor resolution (incl. black pixels)	692 × 504 pixels
Frame rate	62 fps
Video format	12-bit, single tap
Scanning	progressive
Pixel size (H×V)	9.9 × 9.9 μm
Sensor size (H×V)	7.48 × 6.15 mm
Shutter	global, 5 μs – 60000 ms (default 16 ms)
Operating (trigger) modes	<ul style="list-style-type: none">• Free running• Triggered mode• Long range exposure mode
Gain & black level	<ul style="list-style-type: none">• Analog gain: -6 .. 30 dB (default 4 dB)• Digital gain: n/a• Black level: 0 .. 25.5 DN (default 0 DN)
Auto functions	<ul style="list-style-type: none">• n/a
Area of interest (AOI)	Vertical AOI applicable directly at the sensor
Binning	<ul style="list-style-type: none">• Vertical: 2×
Decimation	<ul style="list-style-type: none">• n/a
Mount	C-mount (CS-mount on request)
Dimension	<ul style="list-style-type: none">• 44.8×31.4×91.7 mm (W×H×L, without connectors) — standard version• 44.8×37.56×96.0 mm (W×H×L, without connectors) — right angle version
Weight	145 g
Power input	10-26V/5W

Ordering information

Ordering number	Product name	Option
120202	PicSight P32M-GigE-AS	Hirose/SDR-26 connector
120203	PicSight P32M-GigE-AS-H	Hirose/SDR-26 connector, 90° lens mount
120227	PicSight P32M-GigE-PoE-S	PoE, Hirose/SDR-26 connector
120228	PicSight P32M-GigE-PoE-S-H	PoE, Hirose/SDR-26 connector, 90° lens mount
120302	PicSight P32M-GigE-AS-RTF	Realtime function, lens controller, Hirose/SDR-26 connector
120303	PicSight P32M-GigE-AS-RTF-H	Realtime function, lens controller, Hirose/SDR-26 connector, 90° lens mount
120327	PicSight P32M-GigE-PoE-S-RTF	PoE, Realtime function, lens controller, Hirose/SDR-26 connector
120328	PicSight P32M-GigE-PoE-S-RTF-H	PoE, Realtime function, lens controller, Hirose/SDR-26 connector, 90° lens mount

Check latest price list or contact us to learn if more options are available.

Headquarters (Switzerland)
 Leutron Vision AG
 Industriestrasse 57
 CH-8152 Glattbrugg, Switzerland
 Phone ++41 44 809 88 22
 fax ++41 44 809 88 29
 intsales@leutron.com
www.leutron.com

Germany
 Leutron Vision GmbH
 Macairestrasse 3
 D-78467 Konstanz, Germany
 Phone ++49 7531 5942 0
 fax ++49 7531 594299
 desales@leutron.com
[>www.leutron.com/de/](http://www.leutron.com/de/)

North America
 Leutron Vision Inc.
 38 East Street
 Halifax, MA 02338, USA
 Phone: ++1 888 442 2269 x1
 Fax: ++1 781 353 3943
 ussales@leutron.com
www.leutron.com/

Czech Republic
 Leutron Vision s.r.o.
 Rokycanska 27
 31200 Plzen, Czech Republic
 Phone: ++420 377 260 342
 czsales@leutron.com
www.leutron.com/