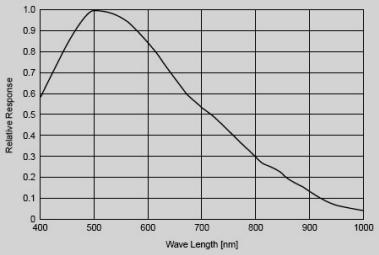

# PicSight P52M-GigE-AS

GigE Vision camera

Technical specifications	
Interface	Ethernet 1000/100/10 Mb/s
Sensor	1/2" CCD, interline transfer, type SONY ICX415
Spectral sensitivity	
Monochrome/color	monochrome
Output image resolution (H×V)	776 × 582 pixels
Full sensor resolution (incl. black pixels)	823 × 592 pixels
Frame rate	63 fps
Video format	12-bit, single tap
Scanning	progressive
Pixel size (H×V)	8.3 × 8.3 μm
Sensor size (H×V)	7.48 × 6.15 mm
Shutter	global, 5 μs –60000 ms (default 15 ms)
Operating (trigger) modes	<ul style="list-style-type: none"> <li>• Free running</li> <li>• Triggered mode</li> <li>• Long range exposure mode</li> </ul>
Gain & black level	<ul style="list-style-type: none"> <li>• Analog gain: -10 .. 26 dB (default 4 dB)</li> <li>• Digital gain: n/a</li> <li>• Black level: 0 .. 25.5 DN (default 0 DN)</li> </ul>
Auto functions	• n/a
Area of interest (AOI)	Vertical AOI applicable directly at the sensor
Binning	• Vertical: 2×
Decimation	• n/a
Mount	C-mount (CS-mount on request)
Dimension	<ul style="list-style-type: none"> <li>• 44.8×31.4×91.7 mm (W×H×L, without connectors) — standard version</li> <li>• 44.8×37.56×96.0 mm (W×H×L, without connectors) — right angle version</li> </ul>
Weight	145 g
Power input	10-26V/5W

## Ordering information

Ordering number	Product name	Option
130202	PicSight P52M-GigE-AS	Hirose/SDR-26 connector
130203	PicSight P52M-GigE-AS-H	Hirose/SDR-26 connector, 90° lens mount
130227	PicSight P52M-GigE-PoE-S	PoE, Hirose/SDR-26 connector
130228	PicSight P52M-GigE-PoE-S-H	PoE, Hirose/SDR-26 connector, 90° lens mount
130302	PicSight P52M-GigE-AS-RTF	Realtime function, lens controller, Hirose/SDR-26 connector
130303	PicSight P52M-GigE-AS-RTF-H	Realtime function, lens controller, Hirose/SDR-26 connector, 90° lens mount
130327	PicSight P52M-GigE-PoE-S-RTF	PoE, Realtime function, lens controller, Hirose/SDR-26 connector
130328	PicSight P52M-GigE-PoE-S-RTF-H	PoE, Realtime function, lens controller, Hirose/SDR-26 connector, 90° lens mount

Check latest price list or contact us to learn if more options are available.

**Headquarters (Switzerland)**  
 Leutron Vision AG  
 Industriestrasse 57  
 CH-8152 Glattbrugg, Switzerland  
 Phone ++41 44 809 88 22  
 fax ++41 44 809 88 29  
 intsales@leutron.com  
[www.leutron.com](http://www.leutron.com)

**Germany**  
 Leutron Vision GmbH  
 Macairestrasse 3  
 D-78467 Konstanz, Germany  
 Phone ++49 7531 5942 0  
 fax ++49 7531 594299  
 desales@leutron.com  
[>www.leutron.com/de/](http://www.leutron.com/de/)

**North America**  
 Leutron Vision Inc.  
 38 East Street  
 Halifax, MA 02338, USA  
 Phone: ++1 888 442 2269 x1  
 Fax: ++1 781 353 3943  
 ussales@leutron.com  
[www.leutron.com/](http://www.leutron.com/)

**Czech Republic**  
 Leutron Vision s.r.o.  
 Rokycanska 27  
 31200 Plzen, Czech Republic  
 Phone: ++420 377 260 342  
 czsales@leutron.com  
[www.leutron.com/](http://www.leutron.com/)