



PicSight.com

P33M-Smartx02-AR

Smart GigE monochrome camera

- 1/3 inch progressive scan CCD
- 656 × 494 square pixels
- 62 fps, 12-bit image data
- high sensitivity
- async reset, full frame shutter
- trigger in, strobe out, video out (CVBS)
- 32-bit RISC processor
- real-time operating system





1/3" CCD Sensor	SONY ICX424
Readout	interline transfer
Sensor size (H×V)	5.79 × 4.89 mm
Output image resolution (H×V)	656 × 494 pixels
Pixel size	7.4 × 7.4 μm
Color	monochrome
Scan	progressive
Frame rate	62 frames/sec
Shutter	global
Max. shutter time	20 ms
Min. shutter time	10 μs
Lens mount	C-mount
Optional lens mount	90-degree C-mount

Spectral sensitivity

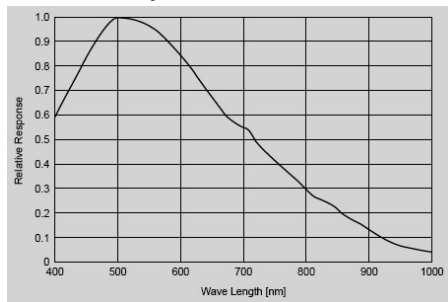

Interface

Ethernet	10/100/1000 Mbit/sec
Processor — P33M-Smart502-AR	PNX0192/300MHz 64MB RAM, 32MB Flash
Processor — P33M-Smart702-AR	PNX1702/500MHz, Hardware FPU 256MB RAM, 64MB Flash
Digital input	2× Optocoupler, 1× TTL
Digital output	3× Optocoupler, 1× TTL
Power req. 12 V/6W	P33M-Smart (old version)
Power req. 10-26V/5W	P33M-Smartx02-AR
Weight	145 g
Operating temperature	0–50 °C

Realtime function

FPGA XC3S500E	Look up table
----------------------	---------------

Embedded software

Compiler/OS	C, C++/Real-time OS
--------------------	---------------------

Host (PC) software

GigE Vision	Any GigE Vision API
API LV-SDS	C, C++, OCX, .Net
Configuration	Web interface
Application upload	FTP

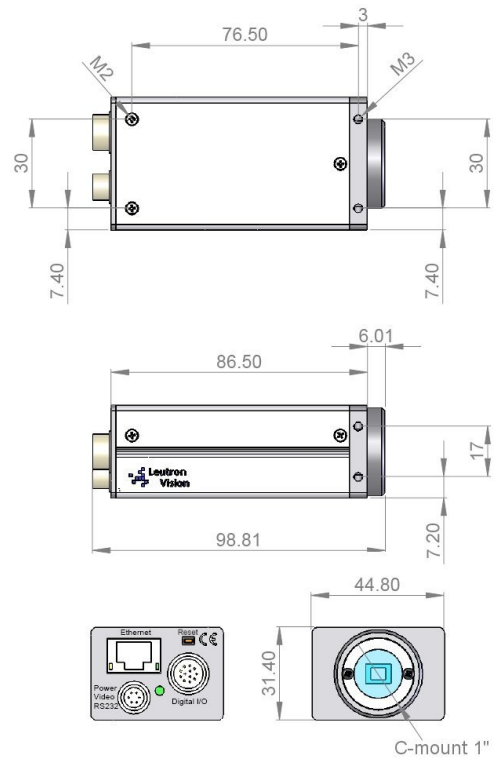

Hirose 12-pin connector, male, HR10A-10R-12PB-71		Hirose 6-pin connector, male, HR10A-7R-6PB-73	
Pin	Signal	Pin	Signal
1	Opto Output Tap	1	TXD Output
2	Opto Output Common Emitter	2	RXD Input
3	Opto Output Collector 0	3	Ground
4	Opto Output Collector 1	4	Video Out (CVBS)
5	Opto Output Collector 2	5	Ground
6	P33M-Smart-Ax: TTL output , P33M-Smart: Opto Output Collector 3	6	Power Input
7	Power Input		
8	Opto Input 1		
9	Opto Input 0		
10	Opto Input Common		
11	Trigger Input TTL		
12	Ground		

Ordering numbers

Number	Product name	Option
110650	PicSight P33M-Smart702-AR	
110651	PicSight P33M-Smart702-AR-H	90° lens mount
100600	PicSight P33M-Smart502-AR	
100601	PicSight P33M-Smart502-AR-H	90° lens mount
999010	Mounting plate	For GigE/Smart cameras
999020	Mounting plate	For GigE-H/Smart-H cameras
16028	LV-SDS	Software API

International headquarters Switzerland
 Leutron Vision AG
 Industriestrasse 57
 CH-8152 Glattbrugg, Switzerland
 Phone ++41 44 809 88 22
 fax ++41 44 809 88 29
 intsales@leutron.com
www.leutron.com

Germany
 Leutron Vision GmbH
 Macairestrasse 3
 D-78467 Konstanz, Germany
 Phone ++49 7531 5942 0
 fax ++49 7531 594299
 desales@leutron.com
www.leutron-vision.de

North America
 Leutron Vision Inc.
 25 Mall Road – Suite 300
 Burlington, MA 01803, USA
 Phone: ++1 888 442 2269 x1
 Fax: ++1 781 353 3943
 ussales@leutron.com
www.leutron.com/us/

