



PicSight.com

P33M-USB2

USB 2.0 monochrome camera

- 1/3 inch progressive scan CCD
- 656 × 494 square pixels
- up to 62 fps
- high sensitivity
- async reset, full frame shutter
- digital I/O's trigger-in, strobe-out
- 16 MB frame store built-in





1/3" CCD Sensor	SONY ICX424
Readout	interline transfer
Sensor size (H×V)	5.79 × 4.89 mm
Output image resolution (H×V)	656 × 494 pixels
Pixel size	7.4 × 7.4 μm
Color	monochrome
Scan	progressive
Max frame rate to camera memory	62 frames/sec
Sustained frame rate to PC	62 frames/sec
Shutter	global
Max. shutter time	20 ms
Min. shutter time	10 μs
Lens mount	C-mount

Spectral sensitivity

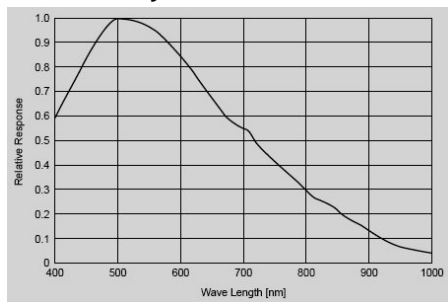

Interface

USB	2.0
Memory	16 MB Framestore
Connector	USB mini-B connector
Status control	Status LED
Power	5 V, USB powered, 2.5 W
Weight	90 g
Operating temperature	0–50 °C
Software	
Camera configuration	LV-SDS camera control
Windows/Linux	API, Camera Editor
Firmware update	With Leutron FW update tool (Windows)

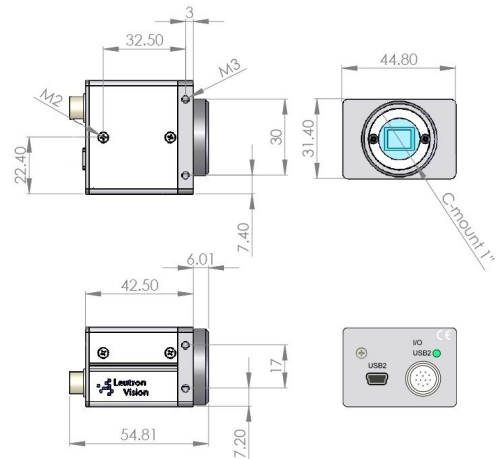

Hirose 12-pin connector, male, HR10A-10R- 12PB-71



Pin	Signal
1	Opto Output Bias Voltage (5–24V)
2	Opto Output Common Emitter
3	Opto Output Collector 0
4	Opto Output Collector 1
5	USB signal +
6	USB signal -
7	Power input +5V
8	Opto Input 1 (5–24V)
9	Opto Input 0 (5–24V)
10	Opto Input Common
11	Trigger Input TTL
12	Ground

Ordering numbers

Number	Product name	Option
110150	PicSight P33M-USB2	
110152	PicSight P33M-USB2-R	
999000	Mounting plate	For USB/CL cameras
16028	LV-SDS	Software API

International headquarters Switzerland
 Leutron Vision AG
 Industriestrasse 57
 CH-8152 Glattbrugg, Switzerland
 Phone ++41 44 809 88 22
 fax ++41 44 809 88 29
 intsales@leutron.com
www.leutron.com

Germany
 Leutron Vision GmbH
 Macairestrasse 3
 D-78467 Konstanz, Germany
 Phone ++49 7531 5942 0
 fax ++49 7531 594299
 desales@leutron.com
www.leutron-vision.de

North America
 Leutron Vision Inc.
 38 East Street
 Halifax, MA 02338, USA
 Phone: ++1 888 442 2269 x1
 Fax: ++1 781 353 3943
 ussales@leutron.com
www.leutron.com/

