



PicSight.com

P52B-USB2

USB 2.0 color camera

- 1/2 inch progressive scan CCD
- 776 × 582 square pixels
- up to 63 fps
- high quality bayer decoder
- async reset, full frame shutter
- digital I/O's trigger-in, strobe-out
- 16 MB frame store built-in





<b>1/2" CCD Sensor</b>	<b>SONY ICX415</b>
<b>Readout</b>	interline transfer
<b>Sensor size (H×V)</b>	7.48 × 6.15 mm
<b>Output image resolution (H×V)</b>	776 × 582 pixels
<b>Pixel size</b>	8.3 × 8.3 μm
<b>Color</b>	bayer pattern
<b>Scan</b>	progressive
<b>Max frame rate to camera memory</b>	63 frames/sec
<b>Sustained frame rate to PC</b>	60 frames/sec
<b>Shutter</b>	global
<b>Max. shutter time</b>	20 ms
<b>Min. shutter time</b>	10 μs
<b>Lens mount</b>	C-mount

### Spectral sensitivity

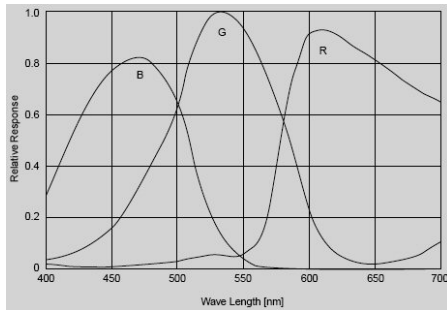

### Interface

<b>USB</b>	2.0
<b>Memory</b>	16 MB Framestore
<b>Connector</b>	USB mini-B connector
<b>Status control</b>	Status LED
<b>Power</b>	5 V, USB powered, 2.5 W
<b>Weight</b>	90 g
<b>Operating temperature</b>	0–50 °C

### Software

<b>Camera configuration</b>	LV-SDS camera control
<b>Windows/Linux</b>	API, Camera Editor
<b>Firmware update</b>	With Leutron FW update tool (Windows)

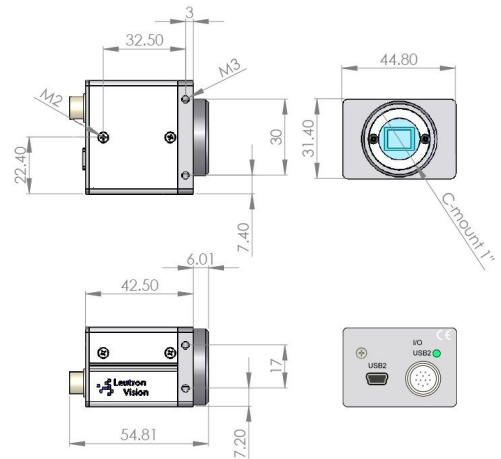

Hirose 12-pin connector, male, HR10A-10R- 12PB-71



Pin	Signal
1	Opto Output Bias Voltage (5–24V)
2	Opto Output Common Emitter
3	Opto Output Collector 0
4	Opto Output Collector 1
5	USB signal +
6	USB signal -
7	Power input +5V
8	Opto Input 1 (5–24V)
9	Opto Input 0 (5–24V)
10	Opto Input Common
11	Trigger Input TTL
12	Ground

### Ordering numbers

Number	Product name	Option
131150	PicSight P52B-USB2	
131152	PicSight P52B-USB2-R	
999000	Mounting plate	For USB/CL cameras
16028	LV-SDS	Software API

**International headquarters Switzerland**  
 Leutron Vision AG  
 Industriestrasse 57  
 CH-8152 Glattbrugg, Switzerland  
 Phone ++41 44 809 88 22  
 fax ++41 44 809 88 29  
 intsales@leutron.com  
[www.leutron.com](http://www.leutron.com)

**Germany**  
 Leutron Vision GmbH  
 Macairestrasse 3  
 D-78467 Konstanz, Germany  
 Phone ++49 7531 5942 0  
 fax ++49 7531 594299  
 desales@leutron.com  
[www.leutron-vision.de](http://www.leutron-vision.de)

**North America**  
 Leutron Vision Inc.  
 38 East Street  
 Halifax, MA 02338, USA  
 Phone: ++1 888 442 2269 x1  
 Fax: ++1 781 353 3943  
 ussales@leutron.com  
[www.leutron.com/](http://www.leutron.com/)

